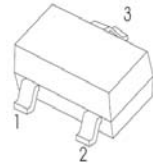
**SOT-23 Plastic-Encapsulate MOSFETS****CJ3406** N-Channel Enhancement Mode Field Effect Transistor

$V_{(BR)DSS}$	$R_{DS(on)MAX}$	I_D
30V	65 mΩ@10V	3.6A
	105 mΩ@4.5V	

SOT-23

1. GATE
2. SOURCE
3. DRAIN

**DESCRIPTION**

The CJ3406 use advanced trench technology to provide excellent $R_{DS(ON)}$ and low gate charge. This device is suitable for use as a load switch or in PWM applications.

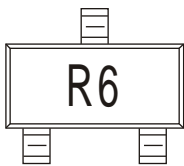
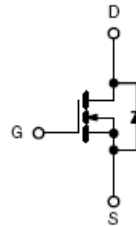
MARKING**Equivalent Circuit****Maximum ratings ($T_a=25^{\circ}C$ unless otherwise noted)**

Parameter	Symbol	Value	Unit
Drain-Source Voltage	V_{DS}	30	V
Gate-Source Voltage	V_{GS}	±20	V
Continuous Drain Current	I_D	3.6	A
Drain Current-Pulsed (note 1)	I_{DM}	15	A
Power Dissipation	P_D	0.35	W
Thermal Resistance from Junction to Ambient	$R_{\theta JA}$	357	$^{\circ}C/W$
Operation Junction and Storage Temperature Range	T_J, T_{STG}	-55~ +150	$^{\circ}C$

MOSFET ELECTRICAL CHARACTERISTICS

$T_a=25\text{ }^\circ\text{C}$ unless otherwise specified

Parameter	Symbol	Test Condition	Min	Typ	Max	Units
STATIC PARAMETERS						
Drain-source breakdown voltage	$V_{(BR)DSS}$	$V_{GS} = 0V, I_D = 250\mu A$	30			V
Zero gate voltage drain current	I_{DSS}	$V_{DS} = 24V, V_{GS} = 0V$			1	μA
Gate-body leakage current	I_{GSS}	$V_{GS} = \pm 20V, V_{DS} = 0V$			± 100	nA
Gate threshold voltage	$V_{GS(th)}$	$V_{DS} = V_{GS}, I_D = 250\mu A$	1		3	V
Drain-source on-resistance (note 2)	$R_{DS(on)}$	$V_{GS} = 10V, I_D = 3.6A$		40	65	m Ω
		$V_{GS} = 4.5V, I_D = 2.8A$		72	105	m Ω
Forward transconductance (note 2)	g_{FS}	$V_{DS} = 5V, I_D = 3.6A$	3			S
Diode forward voltage	V_{SD}	$I_S = 1A$			1	V
DYNAMIC PARAMETERS (note 3)						
Input capacitance	C_{iss}	$V_{DS} = 15V, V_{GS} = 0V, f = 1MHz$			375	pF
Output capacitance	C_{oss}			57		pF
Reverse transfer capacitance	C_{rss}			39		pF
SWITCHING PARAMETERS (note 3)						
Turn-on delay time	$t_{d(on)}$	$V_{GS} = 10V, V_{DS} = 15V,$ $R_L = 2.2\Omega, R_{GEN} = 3\Omega$		4.6		ns
Turn-on rise time	t_r			1.9		ns
Turn-off delay time	$t_{d(off)}$			20.1		ns
Turn-off fall time	t_f			2.6		ns

Notes :

1. Repetitive Rating : Pulse width limited by maximum junction temperature.
2. Pulse Test : Pulse width $\leq 300\mu s$, duty cycle $\leq 0.5\%$.
3. These parameters have no way to verify.

Typical Characteristics

Output Characteristics

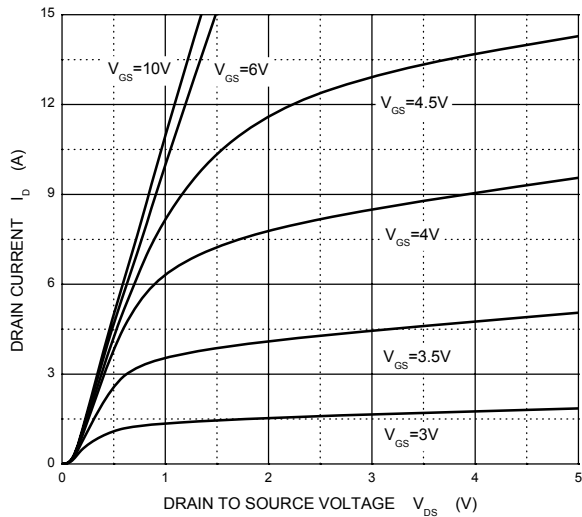

Transfer Characteristics

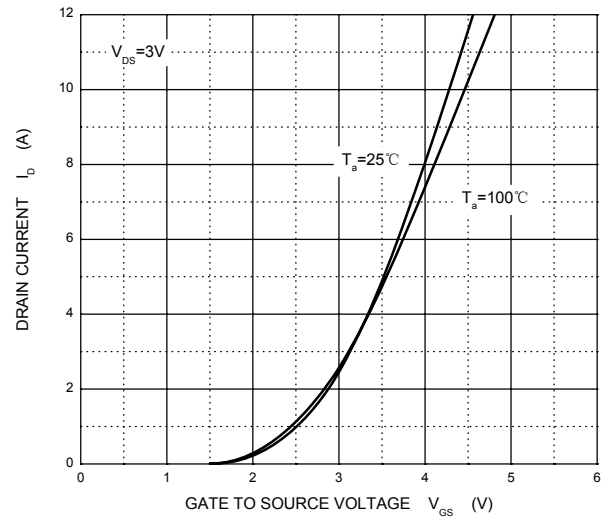

$R_{DS(ON)}$ — I_D

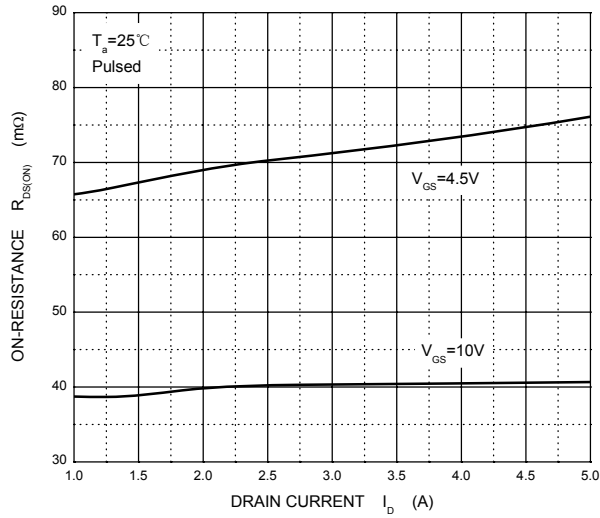

$R_{DS(ON)}$ — V_{GS}

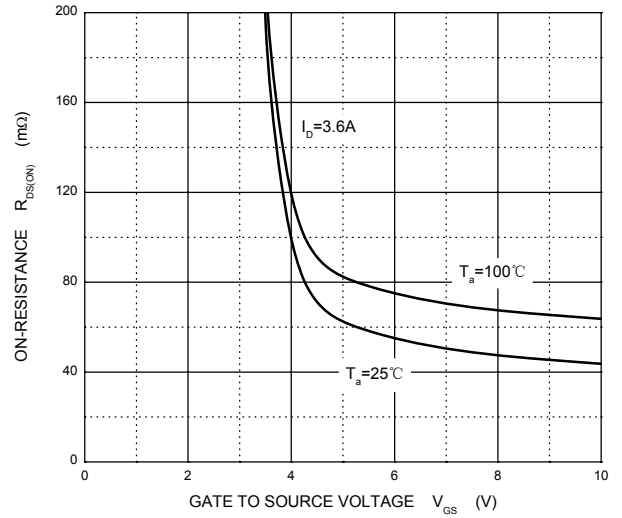

I_S — V_{SD}

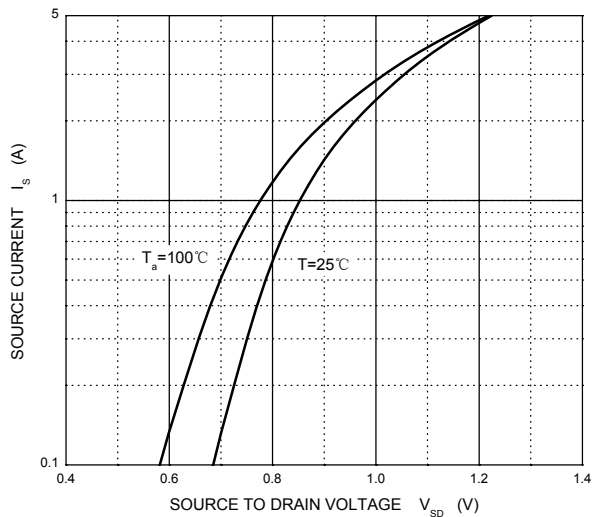

Threshold Voltage

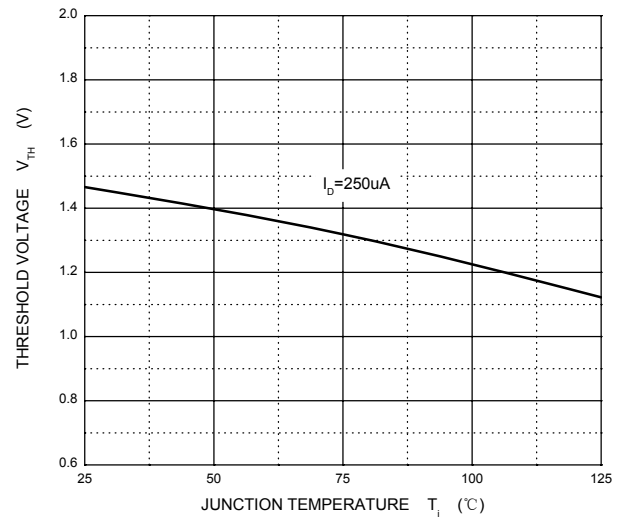

SOT-23 Package Outline Dimensions

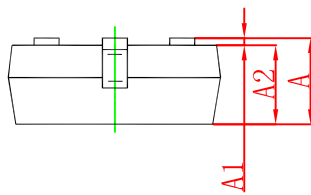
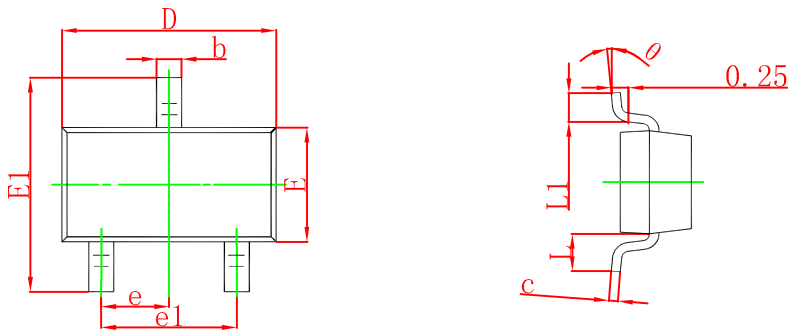

Symbol	Dimensions In Millimeters		Dimensions In Inches	
	Min	Max	Min	Max
A	0.900	1.150	0.035	0.045
A1	0.000	0.100	0.000	0.004
A2	0.900	1.050	0.035	0.041
b	0.300	0.500	0.012	0.020
c	0.080	0.150	0.003	0.006
D	2.800	3.000	0.110	0.118
E	1.200	1.400	0.047	0.055
E1	2.250	2.550	0.089	0.100
e	0.950 TYP		0.037 TYP	
e1	1.800	2.000	0.071	0.079
L	0.550 REF		0.022 REF	
L1	0.300	0.500	0.012	0.020
θ	0°	8°	0°	8°

SOT-23 Suggested Pad Layout

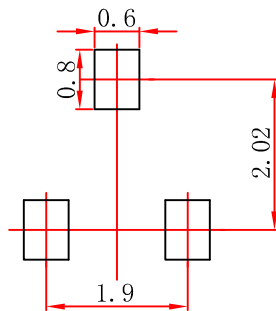

- Note:
1. Controlling dimension: in millimeters.
 2. General tolerance: $\pm 0.05\text{mm}$.
 3. The pad layout is for reference purposes only.

NOTICE

JSCJ reserves the right to make modifications, enhancements, improvements, corrections or other changes without further notice to any product herein. JSCJ does not assume any liability arising out of the application or use of any product described herein.

SOT-23 Tape and Reel

SOT-23 Embossed Carrier Tape

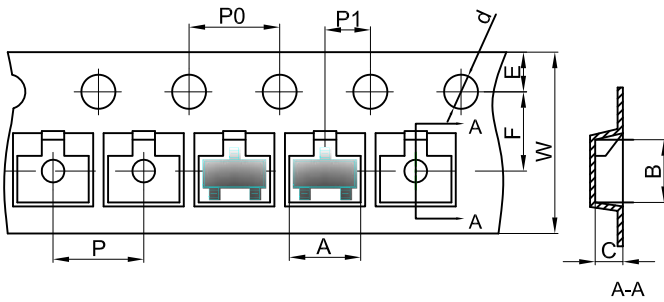

Packaging Description:

SOT-23 parts are shipped in tape. The carrier tape is made from a dissipative (carbon filled) polycarbonate resin. The cover tape is a multilayer film (Heat Activated Adhesive in nature) primarily composed of polyester film, adhesive layer, sealant, and anti-static sprayed agent. These reeled parts in standard option are shipped with 3,000 units per 7" or 17.8cm diameter reel. The reels are clear in color and is made of polystyrene plastic (anti-static coated).

Dimensions are in millimeter

Pkg type	A	B	C	d	E	F	P0	P	P1	W
SOT-23	3.15	2.77	1.22	Ø1.50	1.75	3.50	4.00	4.00	2.00	8.00

SOT-23 Tape Leader and Trailer

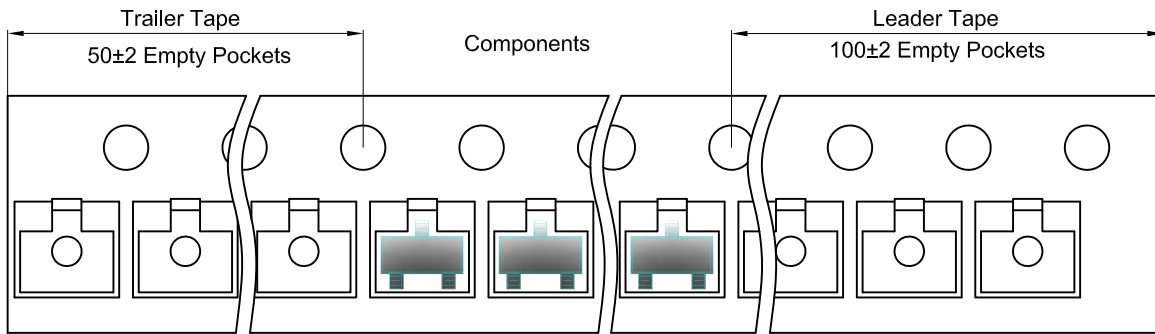

SOT-23 Reel

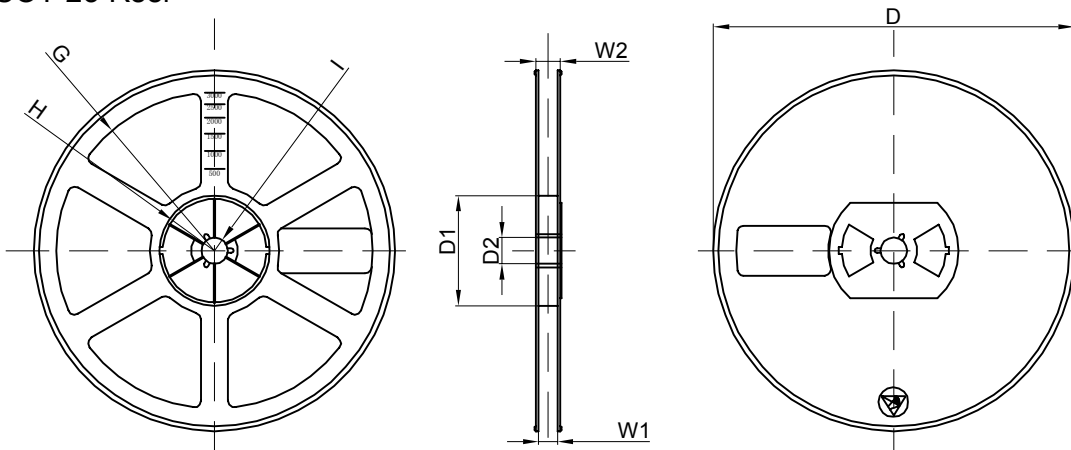

Dimensions are in millimeter

Reel Option	D	D1	D2	G	H	I	W1	W2
7"Dia	Ø178.00	54.40	13.00	R78.00	R25.60	R6.50	9.50	12.30

REEL	Reel Size	Box	Box Size(mm)	Carton	Carton Size(mm)	G.W.(kg)
3000 pcs	7 inch	45,000 pcs	203×203×195	180,000 pcs	438×438×220	